

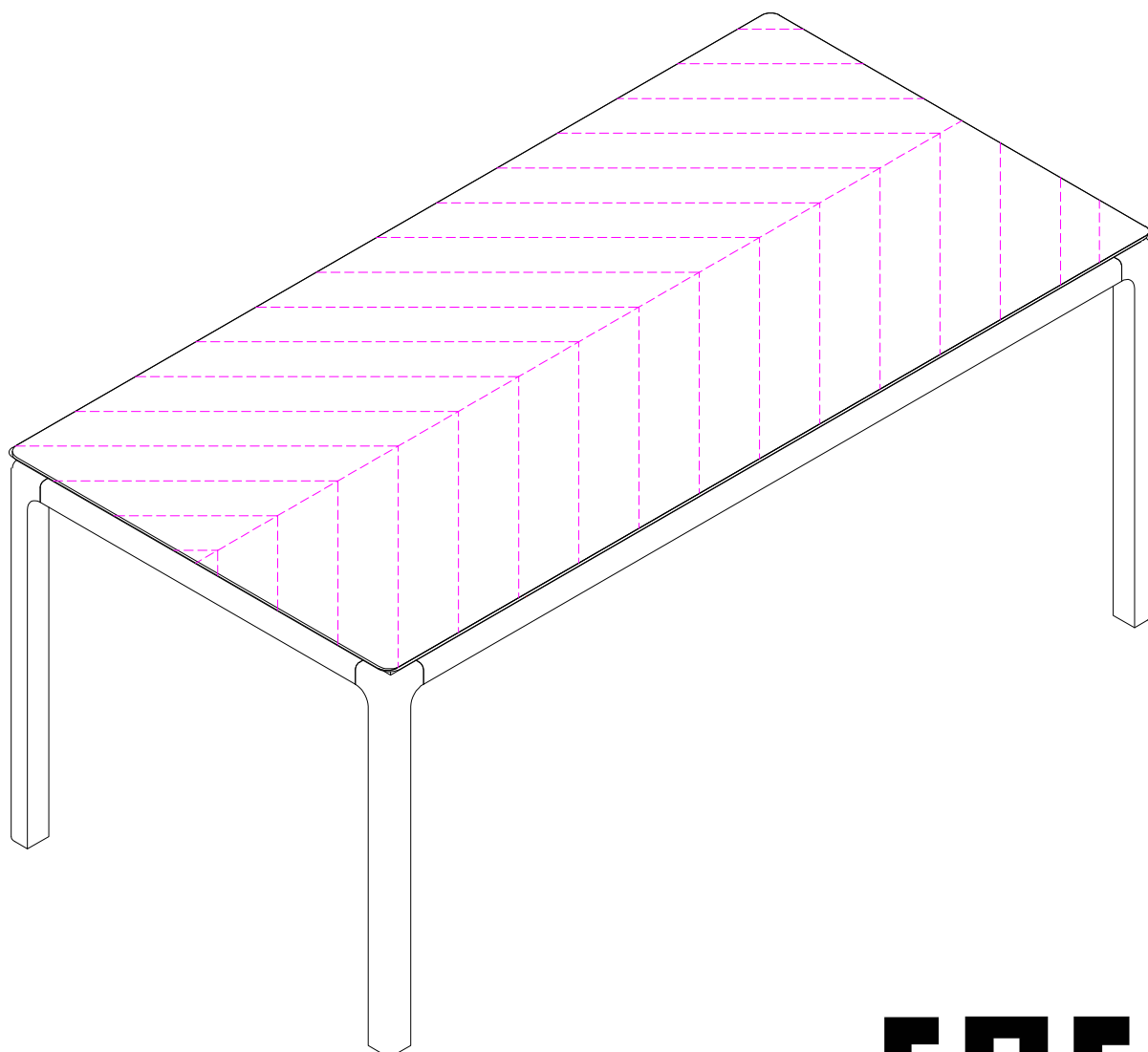

VC.VOL.DT.11.1



EAC

VC.VOL.DT.11.1

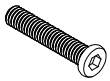
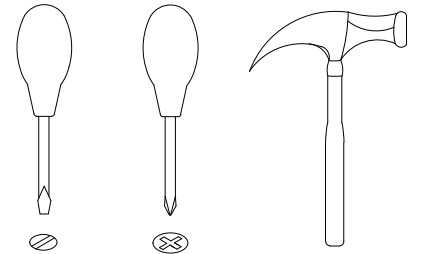
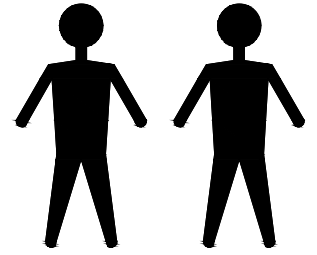

A x6
Spec: 5/16*L60



B x20
Spec: $\phi 18 * \phi 8.2$



C x4
Spec: M8*L95



D x4
Spec:



E x4
Spec: M8

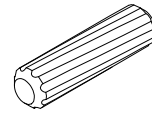

F x8
Spec: $\phi 12 * 50$

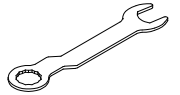

G x1
Spec: 14#



H x1
Spec: 5#



I x14
Spec: 5/16*L40



K x1
Spec: 10g

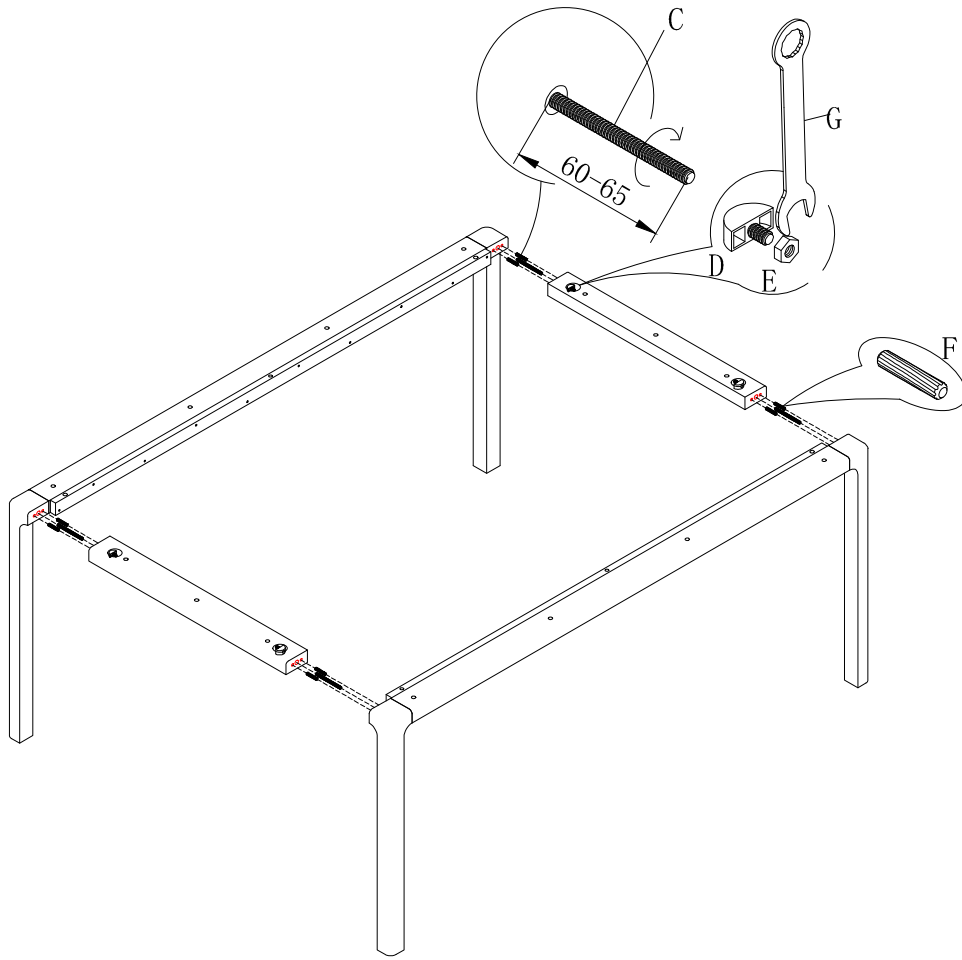

2

